

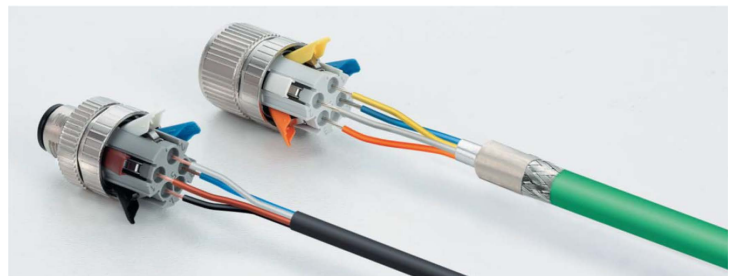

■ Connectivity Solutions

# LUTZE

## M12 Connectors with Push-In Technology



# Actuator sensor interface M12 - connector

Field wireable connector, M12 straight

Male / Female A-coded

Spring terminal: Push-in connection technology



### Dimensions

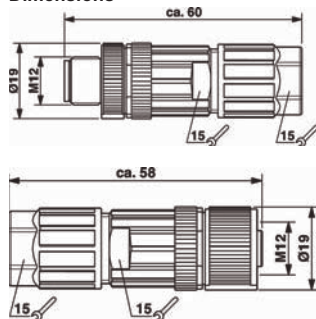

### Pin layout

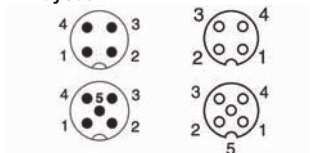

Description	Part-No.	Type	PU	
<b>Male</b>				
Pole number	4	490190 S*	STGK-M12 4-POL-A FK	1
	5	490191 S*	STGK-M12 5-POL-A FK	1
<b>Female</b>				
Pole number	4	490192 S*	KUGK-M12 4-POL-A FK	1
	5	490193 S*	KUGK-M12 5-POL-A FK	1

Technical data	Male		Female	
Part-No.	490190	490191	490192	490193
Rated voltage $U_N$	AC/DC 24 V			
Rated voltage max.	250 V	60 V	250 V	60 V
Rated current	4 A			
Pole number	4	5	4	5
Status indication	-			
Current Consumption	- mA			
Coding	A			
Shielding	-			
<b>General</b>				
Connection type	Spring terminal Push-In			
Design	M 12×1 male straight		M 12×1 female straight	
Rated insulation voltage (EN 50178)	-			
Test voltage	2500 V	1500 V	2500 V	1500 V
Degree of pollution	3			
Insulation resistance	> 100 MΩ			
Contact resistance	< 5 mΩ			
Flamability according to UL 94	V0			
Protection class	IP65, IP67 inserted and tightened			
Housing material	PA 6.6			
Color of the housing	black			
Contact material	CuSn, gold-plated			
Material knurled nut	Zinc die-casting, nickel-plated			
Material sealing ring	NBR			
Cross-section, metric	without AE: 0.14–0.75 mm <sup>2</sup> with AE: 0.14–0.5 mm <sup>2</sup>			
Cross-section AWG	without AE: AWG26–AWG18 with AE: AWG28–AWG20			
Cable diameter	4 – 8 mm			
Tightening torque	M12-knurled nut: 0.4 Nm sleeve housing: 0.4 Nm pressure nut: 1.5 Nm			
Storage temperature range	-40 °C ... +85 °C			
Temperature range connector	-40 °C ... +85 °C			
Mechanical service life	>100 insertion cycles			
Weight (kg/piece)	0.026			
Approvals	cULus (E224249)			
Standards	IEC 61076-2-101, EN 50155 (2001) vibration and shock			

### Mounting diagram

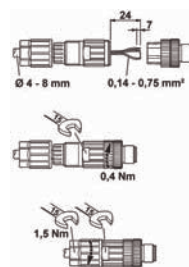

### Mounting diagram

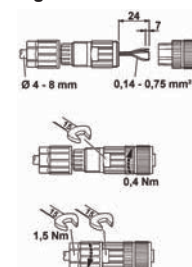

# Actuator sensor interface M12 - connector

Field wireable connector, M12 angled

Male / female A-coded

Spring terminal: Push-in connection technology



Description	Part-No.	Type	PU
<b>Male</b>			
Pole number	4	490194 S*	STWK-M12 4-POL-A FK 1
	5	490195 S*	STWK-M12 5-POL-A FK 1
<b>Female</b>			
Pole number	4	490196 S*	KUWK-M12 4-POL-A FK 1
	5	490197 S*	KUWK-M12 5-POL-A FK 1

Technical data	Male		Female	
Part-No.	490194	490195	490196	490197
Rated voltage $U_N$	AC/DC 24 V			
Rated voltage max.	250 V	60 V	250 V	60 V
Rated current	4 A			
Pole number	4	5	4	5
Cable length	- m			
Status indication	-			
Current Consumption per LED	- mA			
Coding	A			
Shielding	-			

General	
Connection type	Spring terminal Push-In
Design	M 12×1 male angle connector M 12×1 female angle connector
Rated insulation voltage (EN 50178)	-
Mounting	Coding can be rotated in the 45° increments
Test voltage	2500 V 1500 V 2500 V 1500 V
Degree of pollution	3
Insulation resistance	> 100 MΩ
Contact resistance	< 5 mΩ
Flamability according to UL 94	V0
Protection class	IP65, IP67 inserted and tightened
Housing material	PA 6.6
Color of the housing	black
Contact material	CuSn, gold-plated
Material knurled nut	Zinc die-casting, nickel-plated
Material sealing ring	- NBR
Cross-section, metric	without AE: 0.14–0.75 mm <sup>2</sup> with AE: 0.14–0.5 mm <sup>2</sup>
Cross-section AWG	without AE: AWG26–AWG18 with AE: AWG28–AWG20
Cable diameter	4 – 8 mm
Tightening torque	M12-knurled nut: 0.4 Nm sleeve housing: 0.4 Nm pressure nut: 1.5 Nm
Storage temperature range	-40 °C ... +85 °C
Temperature range connector	-40 °C ... +85 °C
Mechanical service life	>100 insertion cycles
Weight (kg/piece)	0.022
Approvals	cULus (E224249)
Standards	IEC 61076-2-101, EN 50155 (2001) vibration and shock

## Dimensions

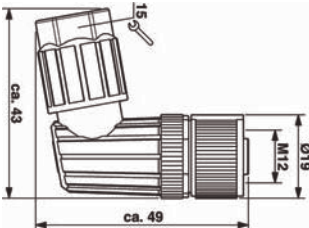
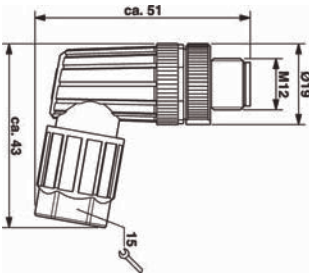

## Pin layout

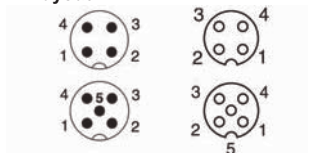

## Mounting diagram

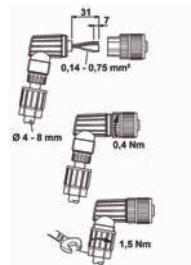

## Mounting diagram

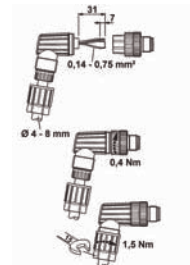

# Actuator sensor interface M12 - connector

Field wireable connector, M12 straight, shielded  
 Male / female A, B or D-coded (Ethernet, Profinet, Sercos)  
 Spring terminal: Push-in connection technology



Description	Part-No.	Type	PU
<b>Male</b>			
Coding	A	490200 S*	STGK5-M12 (C)-A FK 1
	B	490210 S*	STGK2-M12 (C)-B FK 1
	D	490212 S*	STGK4-M12 (C)-D FK 1
<b>Female</b>			
Coding	A	490201 S*	KUGK5-M12 (C)-A FK 1
	B	490211 S*	KUGK2-M12 (C)-B FK 1
	D	490213 S*	KUGK4-M12 (C)-D FK 1

Technical data	Male			Female		
Part-No.	490200	490210	490212	490201	490211	490213
Rated voltage $U_N$	AC/DC 24 V					
Rated voltage max.	60 V					
Rated current	4 A					
Pole number	5	2	4	5	2	4
Status indication	-					
Current Consumption	- mA					
Coding	A	B	D	A	B	D
Shielding	-					

General	
Connection type	Spring terminal Push-In
Design	M 12x1 male straight M 12x1 female straight
Rated insulation voltage (EN 50178)	-
Test voltage	1500 V
Degree of pollution	3
Insulation resistance	> 100 MΩ
Contact resistance	< 5 mΩ
Flamability according to UL 94	V0
Protection class	IP65, IP67 inserted and tightened
Housing material	Zinc die-casting, nickel-plated
Color of the housing	silver
Contact material	CuSn, gold-plated
Material knurled nut	Zinc die-casting, nickel-plated
Material sealing ring	NBR
Cross-section, metric	without AE: 0.14–0.75 mm <sup>2</sup> with AE: 0.14–0.5 mm <sup>2</sup>
Cross-section AWG	without AE: AWG26–AWG18 with AE: AWG28–AWG20
Cable diameter	4 – 8 mm
Tightening torque	M12-knurled nut: 0.4 Nm sleeve housing: 0.8 Nm pressure nut: 3 Nm
Storage temperature range	-40 °C ... +85 °C
Temperature range connector	-40 °C ... +85 °C
Mechanical service life	>100 insertion cycles
Weight (kg/piece)	0.037 0.042
Approvals	cULus (E224249)
Standards	IEC 61076-2-101, EN 50155 (2001) vibration and shock

## Dimensions

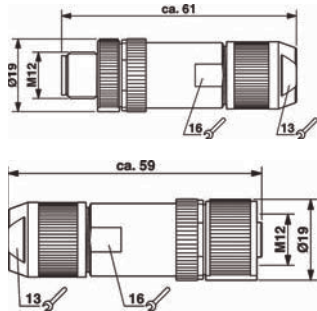

## Pin layout

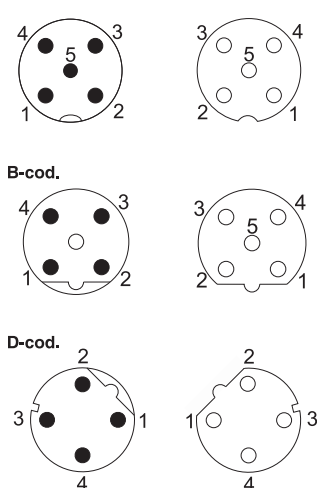

## Mounting diagram

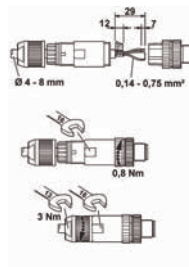

## Mounting diagram

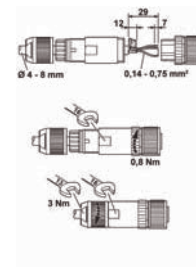

\* S Article from stock  
 A Available with a lead time  
 R Available on request



# Actuator sensor interface M12 - connector

Field wireable connector, M12 angled, shielded  
 Male / female A or D-coded (Ethernet, Profinet, Sercos)  
 Spring terminal: Push-in connection technology



Description	Part-No.	Type	PU
<b>Male</b>			
Pole number	5	490202 S*	STWK5-M12 (C)-A FK 1
	4	490214 S*	STWK4-M12 (C)-D FK 1
<b>Female</b>			
Pole number	5	490203 S*	KUWK5-M12 (C)-A FK 1
	4	490215 S*	KUWK4-M12 (C)-D FK 1

Technical data	Male		Female	
Part-No.	490202	490214	490203	490215
Rated voltage $U_N$	AC/DC 24 V			
Rated voltage max.	60 V			
Rated current	4 A			
Pole number	5	4	5	4
Cable length	- m			
Status indication	-			
Current Consumption per LED	- mA			
Coding	A	D	A	D
Shielding	-			

General	
Connection type	Spring terminal Push-In
Design	M 12×1 male angle connector M 12×1 female angle connector
Rated insulation voltage (EN 50178)	-
Mounting	Coding can be rotated in the 45° increments
Test voltage	1500 V
Degree of pollution	3
Insulation resistance	> 100 MΩ
Contact resistance	< 5 mΩ
Flamability according to UL 94	V0
Protection class	IP65, IP67 inserted and tightened
Housing material	Zinc die-casting, nickel-plated
Color of the housing	silver
Contact material	CuSn, gold-plated
Material knurled nut	Zinc die-casting, nickel-plated
Material sealing ring	NBR
Cross-section, metric	without AE: 0.14–0.75 mm <sup>2</sup> with AE: 0.14–0.5 mm <sup>2</sup>
Cross-section AWG	without AE: AWG26–AWG18 with AE: AWG28–AWG20
Cable diameter	4 – 8 mm
Tightening torque	M12-knurled nut: 0.4 Nm sleeve housing: 0.8 Nm pressure nut: 3 Nm
Storage temperature range	-40 °C ... +85 °C
Temperature range connector	-40 °C ... +85 °C
Mechanical service life	>100 insertion cycles
Weight (kg/piece)	0.039 0.044
Approvals	cULus (E224249)
Standards	IEC 61076-2-101, EN 50155 (2001) vibration and shock

## Dimensions

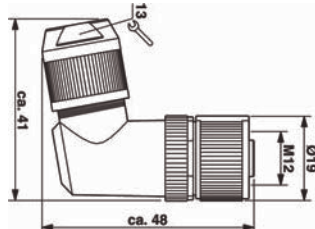
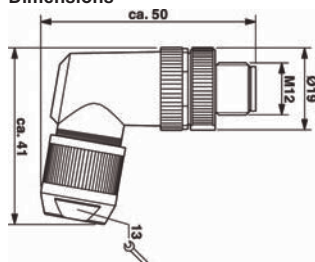

## Pin layout

A-cod.



D-cod.

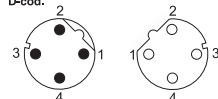

## Mounting diagram

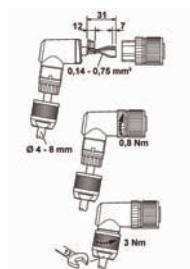

## Mounting diagram

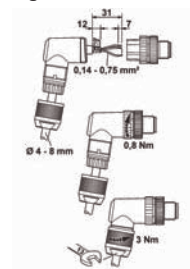

\* S Article from stock  
 A Available with a lead time  
 R Available on request

LUTZE Inc.  
13330 South Ridge Drive  
Charlotte, NC 28273  
Tel.: (704) 504-0222  
Fax: (704) 504-0223  
info@lutze.com

# Efficiency in Automation

Cable • Connectivity • Cabinet • Control

[www.lutze.com](http://www.lutze.com)  
[www.driveflex.com](http://www.driveflex.com)



1-800-447-2371

