

Specifications:

Sound level Category	Medium Sound Level
Mode of Operation	Fast Pulse
Mounting	Panel (see note B)
Voltage Rating	6 to 28 Vac/dc
Frequency	1900 Hz \pm 300 Hz
Loudness (Min. Voltage)	60 dB(A) min @ 2 FT and 6 Vac/dc
Loudness (Max Voltage)	75 dB(A) min @ 2FT and 28 Vac/dc
Current Draw	6 mA Max @ 6 Vac/dc
Current Draw	20 mA Max @ 28 Vac/dc
Min. Pulse Rate (PPS)	2 @ 6 Vac/dc
Max. Pulse Rate (PPS)	10 @ 28 Vac/dc
Duty Cycle (%)	50 (Approx)
Storage Temperature	-40°C to +85°C
Operating Temperature	-30°C to +65°C
Weight (Typical)	2.7 oz (76 g)
Housing	6/6 Nylon, Color Black
Options	For other options contact factory

Dimensions: Inches (mm)

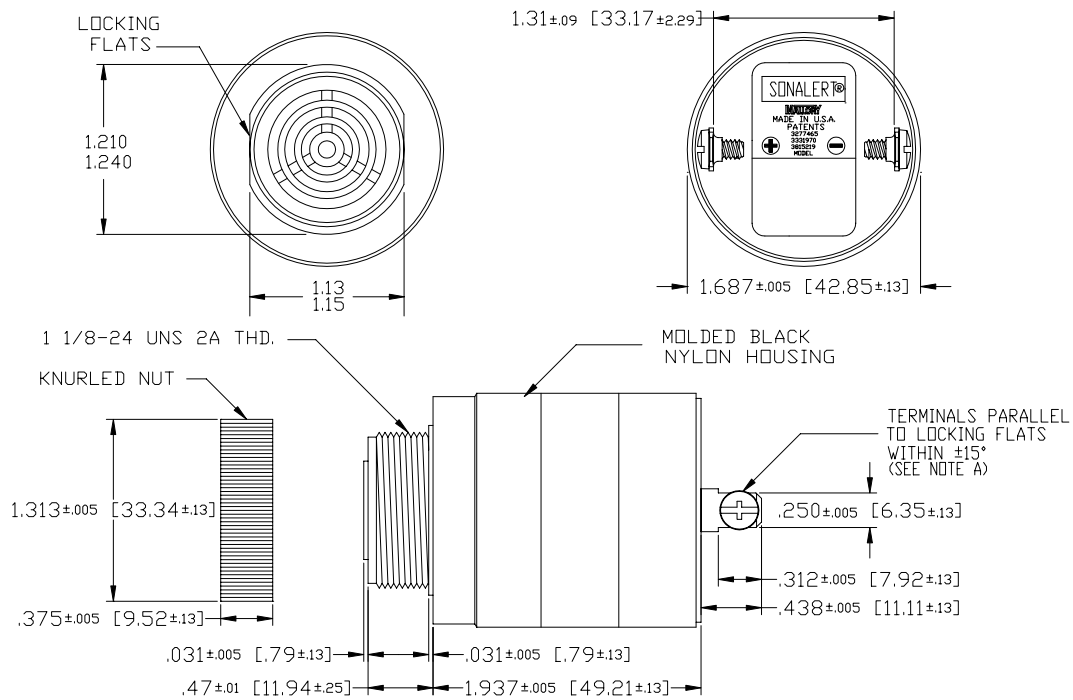

NOTE A: TERMINALS-.032 BRASS TIN PLATED, TAPPED FOR #6-32 SCREW. TWO #6-32 NICKEL PLATED BRASS SCREWS INCLUDED. WILL ACCEPT 1/4" QUICK CONNECT.

NOTE B: MOUNTING- REMOVE BLACK PLASTIC NUT AND INSERT THREADED FRONT THROUGH 1.25" HOLE PUNCHED IN PANEL, IF ORIENTATION IS NEEDED, NOTE LOCKING FLATS ON DRAWING. SCREW NUT BACK ON. DO NOT OVERTIGHTEN.